

Manchester/V100/AdvantEdge Vinyl 2-Panel Sliding Door Installation Guide

IG-009 REV. 08/23 1.7

Not Available for Quartz Luxury.



Manchester V100 AdvantEdge

Scan Here for a Digital Version of the
Installation Guides in English.

Quaker Residential Windows & Doors:
www.quakerresidentialwindows.com



V100

Scan Here for a Digital Version of the
Installation Guides in English.

Quaker Commercial Windows & Doors:
www.quakercommercialwindows.com



Para ver las instrucciones en Espanol, escanea aqui.

If this set of instructions does not match your installation method or the wall conditions of the job site, please check our website listed below for other options, or call Quaker Customer Service for additional information.





















Quaker Window Products
504 U.S. Hwy 63 South
Freeburg, MO 65035
(800) 347-0438
www.quakerwindows.com



PO Box 128 | 504 Highway 63 South | Freeburg, MO 65035 | 800-347-0438 | 573-469-4151 (fax)

Installation Guidelines for Vinyl 2 panel sliding door. New Construction nail fin installation with a drainable weather resistant barrier.

Read these instructions completely before starting any installation. Failure to install and maintain our product according to these instructions may void any product warranty. Please visit our website at www.quakerwindows.com or call 1-800-347-0438 for additional information.

Tools required by installer:		Materials required by installer:	
Safety glasses		Utility knife	
Drill/Driver		Caulk gun	
Level		Tape measure	
Hammer		J-roller	
Putty Knife		Staple Gun	
		Foam Backer Rod	
		Shims (Waterproof)	
		Flashing tape (Self-Adhering)	
		Fasteners	
		Minimally Expanding Foam	
		Sealant	
		Water Resistant Barrier/House Wrap (WRB)	
		IPA Alcohol	
		Drip Cap	

⚠ WARNING

Tools

- Follow manufacturers instructions for safe operation of tools, and ladders/scaffolding. Always wear safety glasses. Failure to do so could result in injury, product or property damage.

Handling

- Do not store units outside, or in a hot or cold environment. Doing so could result in product damage.
- Do not carry flat.** Doing so could result in product damage, injury, or property damage.
- Stack units as straight as possible to avoid bowing. **Do not lay flat!**

Glass

- If broken, glass can fragment causing injury. All Quaker products are available with safety glass. In many areas, local building codes require safety glass in certain locations and/or applications. Unless safety glass is ordered, Quaker windows are not provided with safety glass. Before ordering, consult your local building codes for more definitive information.

Fastening

- Metal fasteners and components could corrode when used with preservative-treated lumber. Use approved fasteners and components to fasten window or door. Failure to do so could cause a failure resulting in injury, product or property damage.
- Fastener must attach to a structural framing member with 1 1/2" minimum fastener embedment, or minimum 3 full threads with a minimum 5/16" head as products were tested with.
- Quaker does not supply anchorage/fastener calculations, and is not responsible for determining structural adequacy of the anchorage and fasteners used to install our products, or the openings into which they are installed.**
- Do not over drive screws or nails.** Doing so could result in product damage.

 **CAUTION**
Installation

- Always support window or door in opening until fully fastened. Failure to do so could result in the window or door falling out or causing injury, product, or property damage.
- Nailing flanges and drip caps (integral or applied) **do not** take the place of window flashing. All windows and doors must be properly flashed and sealed with material compatible sealant for protection against water and air infiltration around the entire perimeter. Failure to do so could result in product or property damage.
- **Do not** set window directly on sill plate. Place shims under the side jambs. Window or door must be properly shimmed. Failure to do so could affect operation and product performance and could result in product damage.
- Live or dead loads transferred into our product can affect functionality, damage frame joinery or cause glass failures. Dead loads such as upper levels, roof, etc. Should be constructed before window or door is installed.
- Loads shall be designed to withstand the most critical effects of load factors and load combinations as required by the building code. (Loads are including but not limited to Live, Dead, Collateral, Auxiliary, Thermally induced, Seismic, etc.)
- Maximum vertical deflection of the header under all Load combination should not exceed the Span/720 or 1/8" whichever is less.
- Windows and doors have small parts. Small parts if swallowed could pose a choking hazard to young children. Dispose of unused, loose, or easily removed small parts. Failure to do so could result in injury.
- **Do not** drill through or into window sill to install alarm wires.

Sealing

- Follow instructions of foam, sealant, and flashing manufacturers regarding safety, material application, compatibility, and periodic maintenance for continued weather resistance of their products. Failure to do so could result in product or property damage. **DO NOT** overfill between the frame and opening.
- Minimally expanding foam insulation must be compliant with AAMA 812-19.
- Quaker recommends 100% silicone (ASTM C920 compliant) neutral cure only sealant. Always clean all areas where sealant will be applied. Failure to do so could result in product or property damage.
- Flashing tape must meet ASTM-D779 performance requirements.
- Maintain a minimum of 1/4" between the window or door frame and exterior finish materials. Failure to do so could result in product or property damage.

Joining

- Do not join any window or door to any window or door not designed for joining. Joined windows and doors must be individually supported in the opening. Failure to do so could affect operation and product performance and could result in product or property damage.

Cleaning

- Acid solutions used for cleaning will damage glass, fasteners, hardware, and metal flashing. Protect these products and follow cleaning products manufacturers instructions. If acid contacts the window or door, wash all surfaces immediately with clean water.
- **Do not** use razor blades to clean glass surface. Glass damage could result.
- Clean glass using liquid glass cleaner.
- Clean frame, sash, panels, and insect screens using mild detergent and warm water with a soft cloth or brush.

IMPORTANT

- Buildings constructed prior to 1978 could contain lead paint which could be disturbed during window or door replacement. For more information on proper management of lead paint, go to: www.epa.gov/lead
- Care must be taken to properly recycle or dispose of old materials. Any recyclable materials should be separated from non-recyclable or hazardous materials. Please consult with local or state authorities regarding proper disposal of non-recyclable or hazardous materials.
- These are generic instructions intended to cover most common situations, which may not be appropriate for all installations due to building design, construction materials, or methods used and/or building or site conditions. Consult a contractor or architect for recommendations.
- Inspect all units for any damage or defects prior to installation. Contact the nearest Quaker distributor if there are any problems.

1



Measure and verify the opening is sized correctly. The rough opening should be a minimum 1/2" (but not to exceed 1") wider and taller than the unit. Check that the opening is square. The diagonal measurements need to be within 1/8" of each other. Verify the rough opening is plumb and level. The sill must be level for proper unit operation.

2

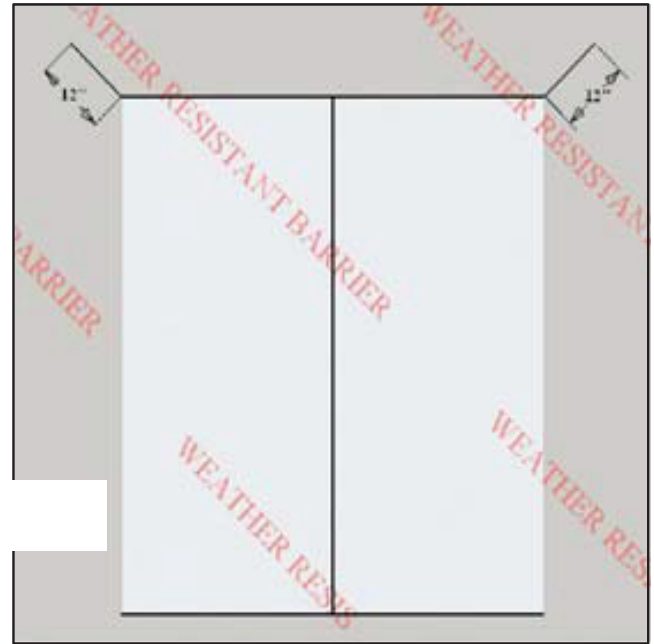

Apply the house wrap according to the manufacturer's instructions and cut T-pattern opening as shown. Cut top flap angles at 45 degrees and 1" longer than the width of the flashing tape being used.

3

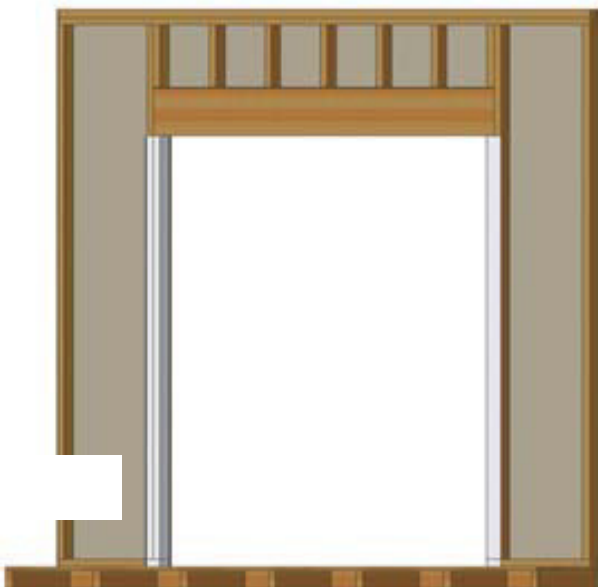

Fold back the house wrap on the sides toward the interior and staple into place.

4

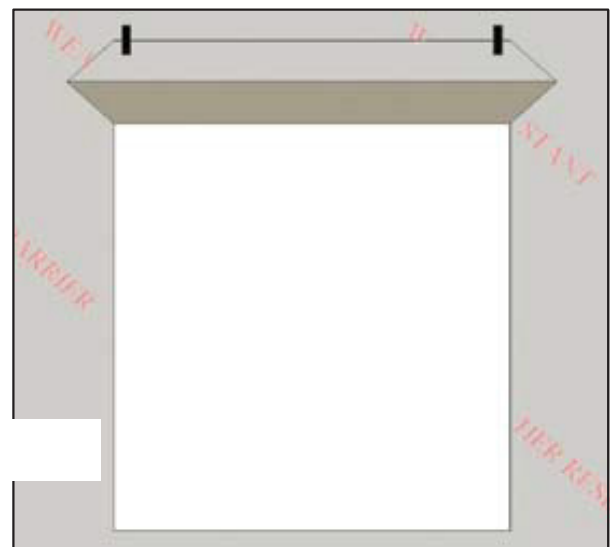

Fold the house wrap flap up and temporarily tape in place.

5

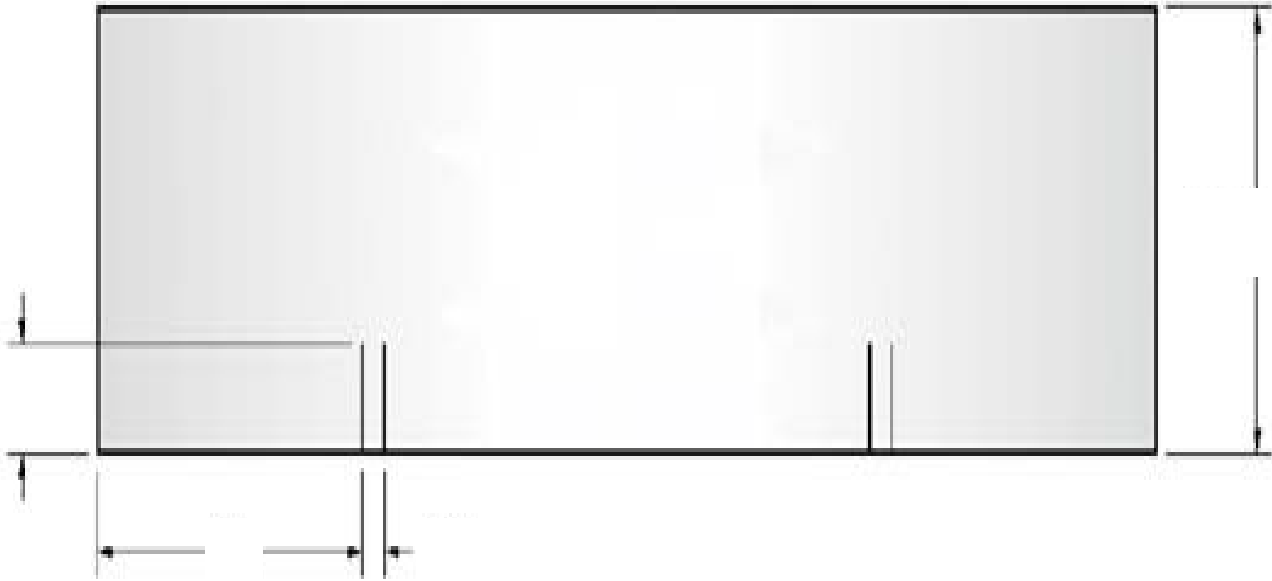

Make a sill pan using flashing that is 6" minimum in width. Flashing must meet ASTM-D779 performance requirements. Measure the width of the rough opening. Cut a length of flashing that is 12" wider than the rough opening. This will allow you to run the flashing 6" up each side. Cut 1 1/2" slits at each end of the flashing as shown below.

6

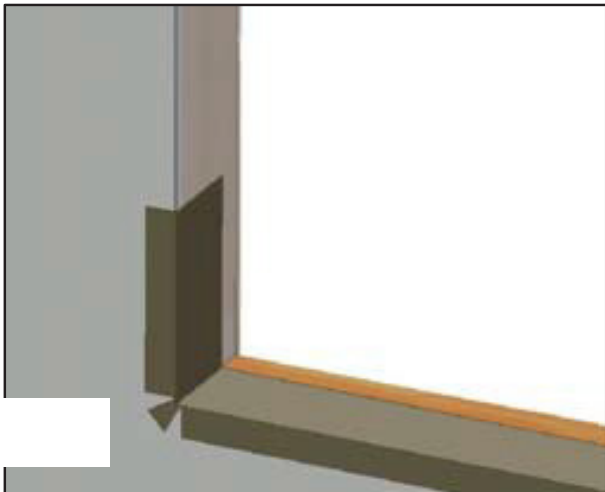

Apply sill flashing to the rough opening as shown below.

7

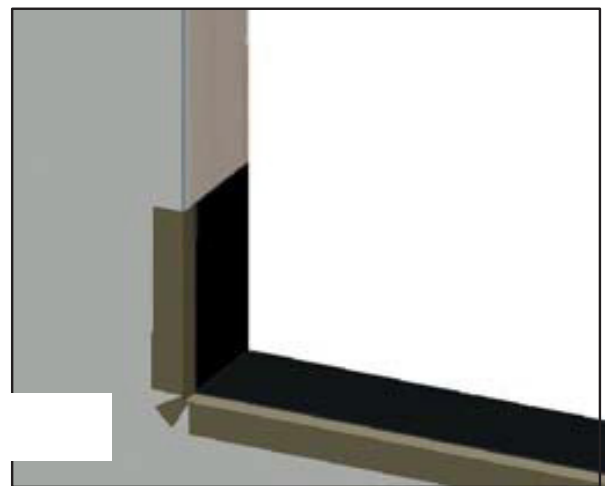

Flashing tape must cover the entire sill. If needed, apply an additional flashing piece over the first one (start from the exterior and work towards the interior). Maintain a minimum 1" overlap.

8



Apply a continuous 3/8" diameter bead of sealant along the backside of the nailing flange. Bead must run around both sides and across the head, in line with and completely covering the nail flange holes.

9

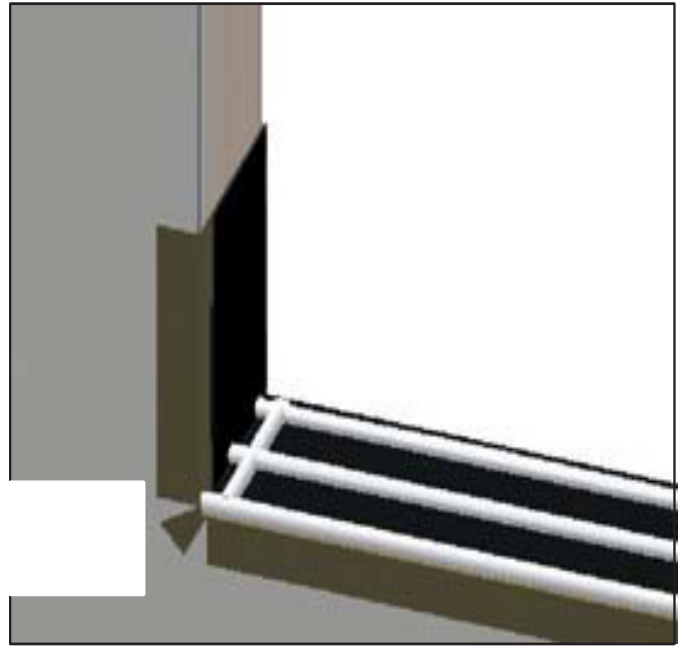

Apply three 3/8" continuous beads of sealant across the entire width of the rough opening sill. Apply a 3/8" continuous bead of silicone 1/2" from each side of the rough opening. The bead will run the entire depth of the jamb starting at the face of the wall.

10



Set the door into the rough opening. Center the unit in the opening, making sure there are equal gaps on both sides of the door. Temporarily tack the door in place using 2" galvanized roofing nails through the pre-punched holes at both top corners of the nailing flange. Start with a shim at each corner no more than 2" from the jamb corner. Add additional shims spaced evenly from the center of the unit. Make sure shims are spaced no more than 16" apart. Additional shims are required at each lock point for all operating doors. Nail all four corners in place through the pre-punched holes in the nailing flange. Finish nailing the door to the rough opening. Use a nail at each nailing fin hole, or a minimum of 12" on center.

11

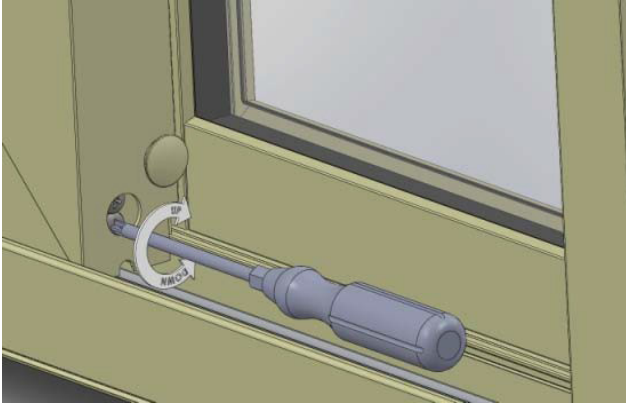

Verify that the installed door is flat, plumb, level and square. Verify that the door is shimmed and fastened properly as stated in these instructions. Verify that the rollers are adjusted to the optimal position. Remove plug and adjust lower screw. May need to adjust both sets of rollers.

12

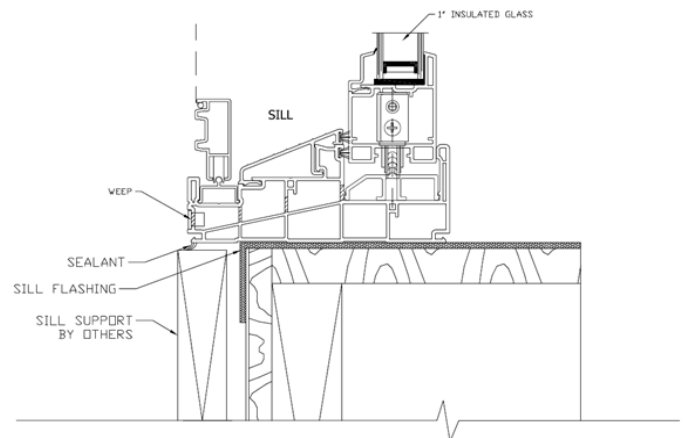

Attach a sill support block beneath the sill. Apply a bead of sealant at the nose of the sill and support block. Make sure sealant doesn't block the bottom sill weep hole covers.

13



Cut and apply side flashing. Side flashing should run from the bottom of the sill flashing to 4" above the rough opening. Cut and apply head flashing. The head flashing should run slightly past the edge of the side flashing as shown. Flip down the top flap of the house wrap. Tape the cut seams of the house wrap.

14

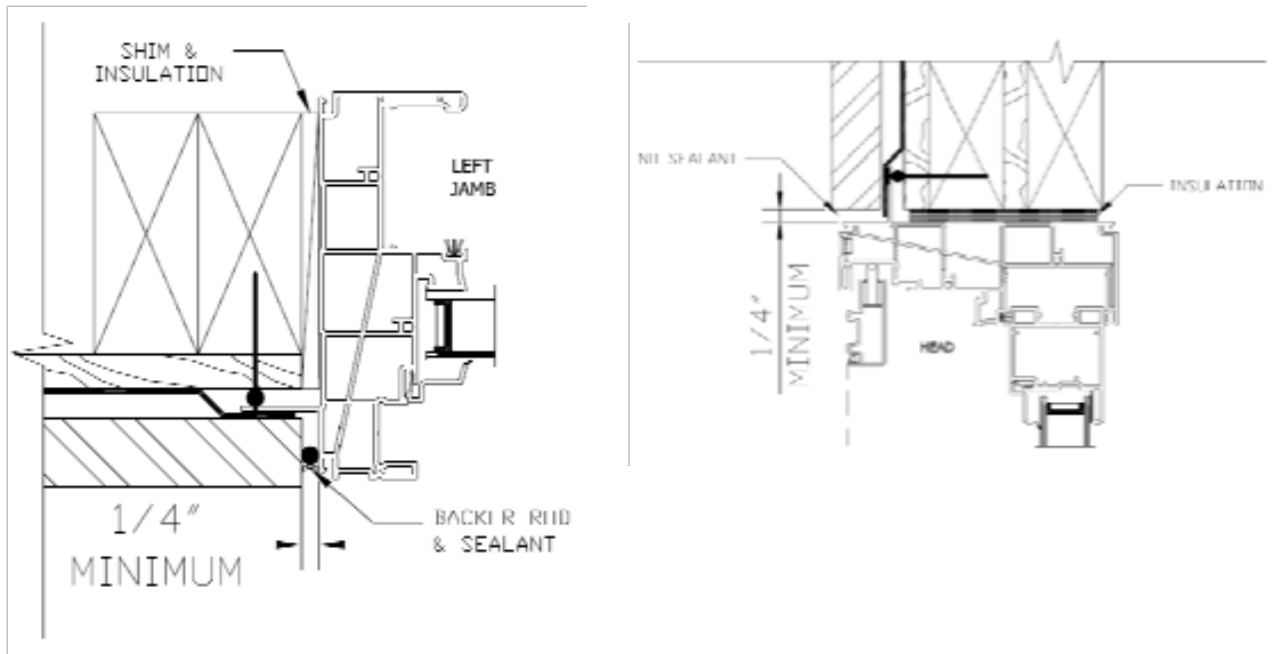

After siding or wall exterior is complete, apply backer rod and sealant between the door frame and siding material on both sides. Warning: Maintain a minimum of $\frac{1}{4}$ " between the door frame and any trim, siding or masonry.

15



Install handle set hardware per instructions found in the hardware box.

16

SILL

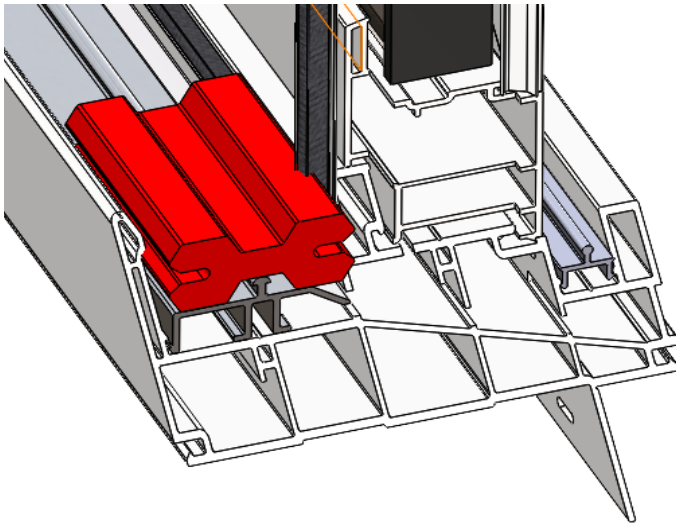

HEAD

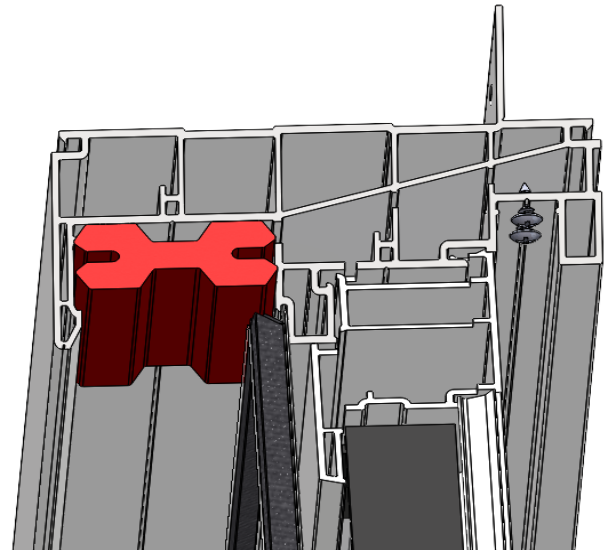

If there are 2 panel bumpers in the sill. Remove 1 of the panel bumpers and install in the same track of the head. Both will be pushed over to the jambs.

17

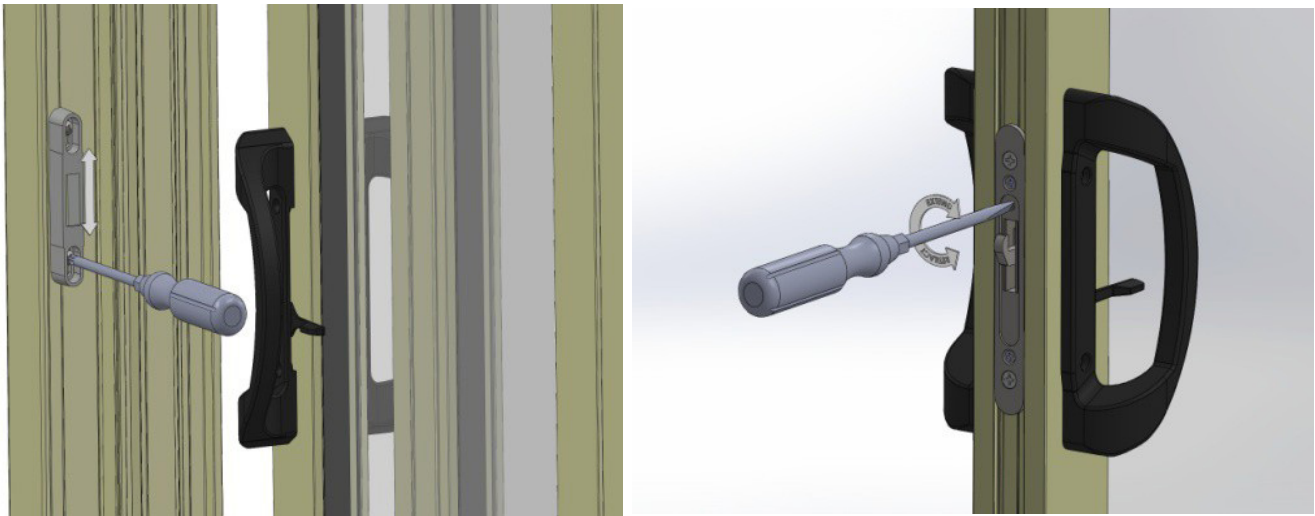

Sliding patio doors: After the operating panel and keeper and lock are adjusted to the optimal position, apply the supplied #10 x 1 1/4" screws through the top and bottom holes of the keeper. Pre-drill the holes using a 1/8" bit prior to assembly.

Insulate between the door frame and the rough opening using minimally expanding window and door spray foam insulation. Use caution to not overfill the gap, causing the jambs to bow. It is not recommended to apply trim to the unit until the foam has cured to allow the excess to escape. Operate door unit to ensure proper operation. The panel will not operate correctly if the door is out of square, over-shimmed or over insulated. Apply the handle set as appropriate per the manufacturer's recommendations. Complete final adjustments as necessary.